

Varenummer: 20192B45B45652SW
Beskrivelse: E+G
T-rørs holder GN192-B45-B45-65-2-SW

Mål

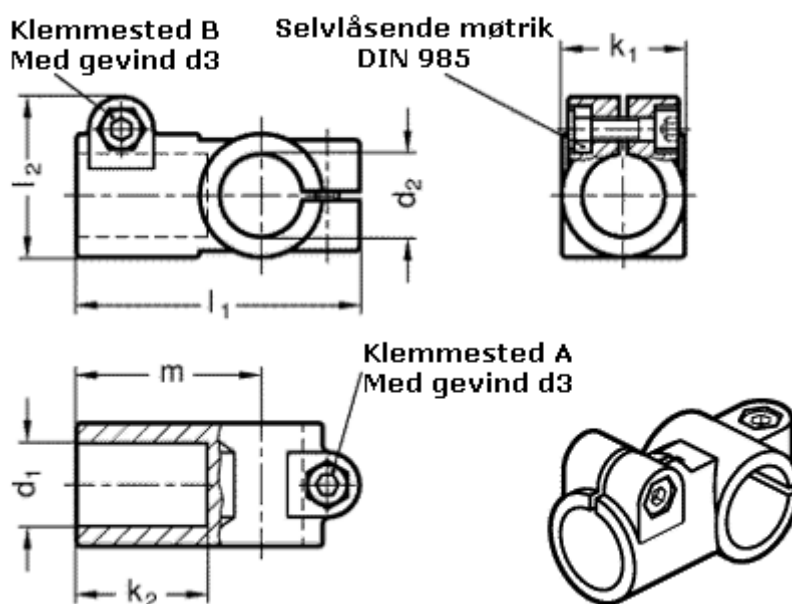

d1 = B45
d2 = B45
d3 = M10
k1 = 65
k2 = 75.0
l1 = 148
l2 = 77.5
m = 103